

043-C: Shake Smart

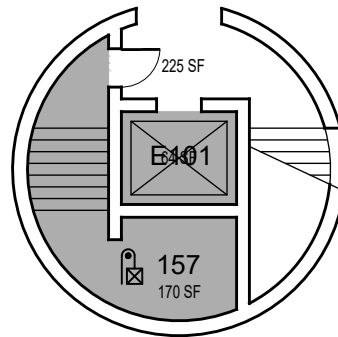

043-A: KINESIOLOGY

March 2022

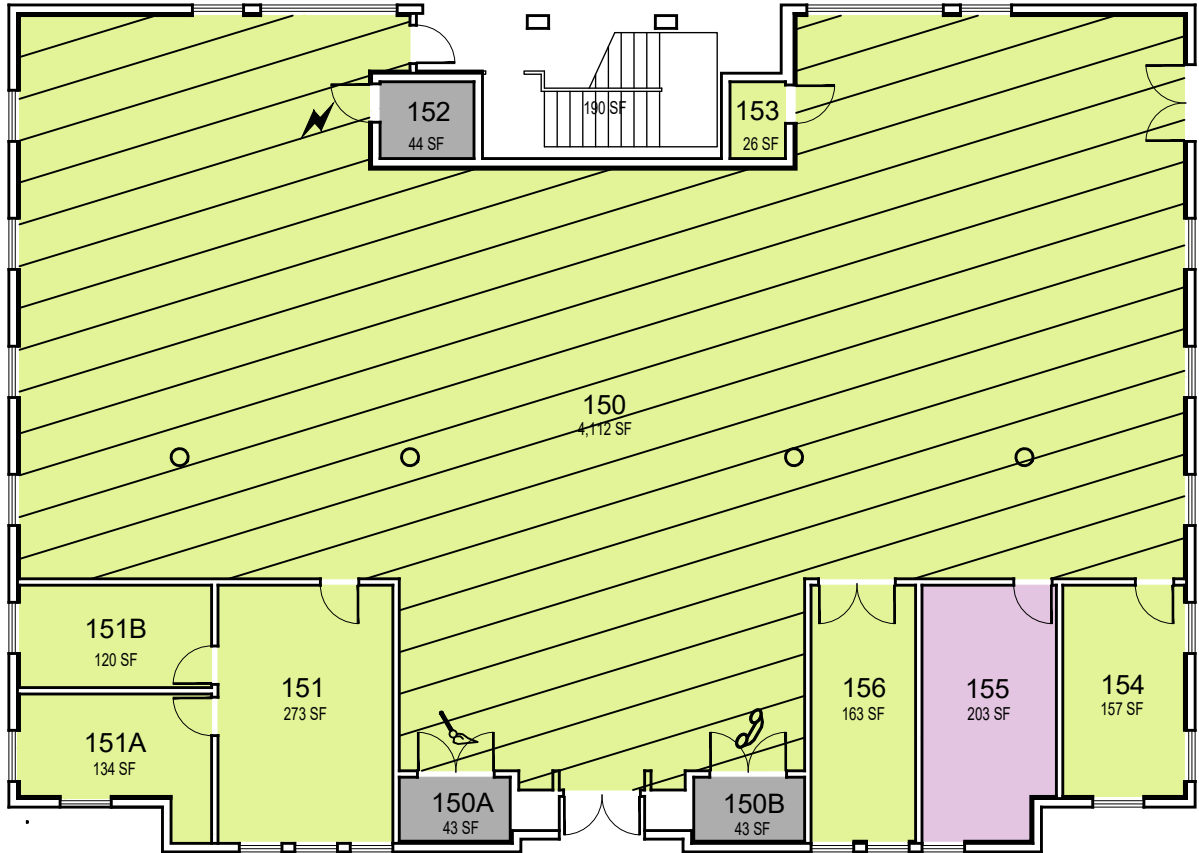

Kinesiology

Floor 1

FACILITIES MANAGEMENT AND DEVELOPMENT

Space Data http://afd.calpoly.edu/facilities/spacefacility/space_data.asp

000 UNASSIGN	400 STUDY	800 HEALTH
100 CLASS	500 SPECIAL	900 RESIDENTIAL
200 LAB	600 GENERAL	
300 OFFICE	700 SUPPORT	



1"=15'

Room Use

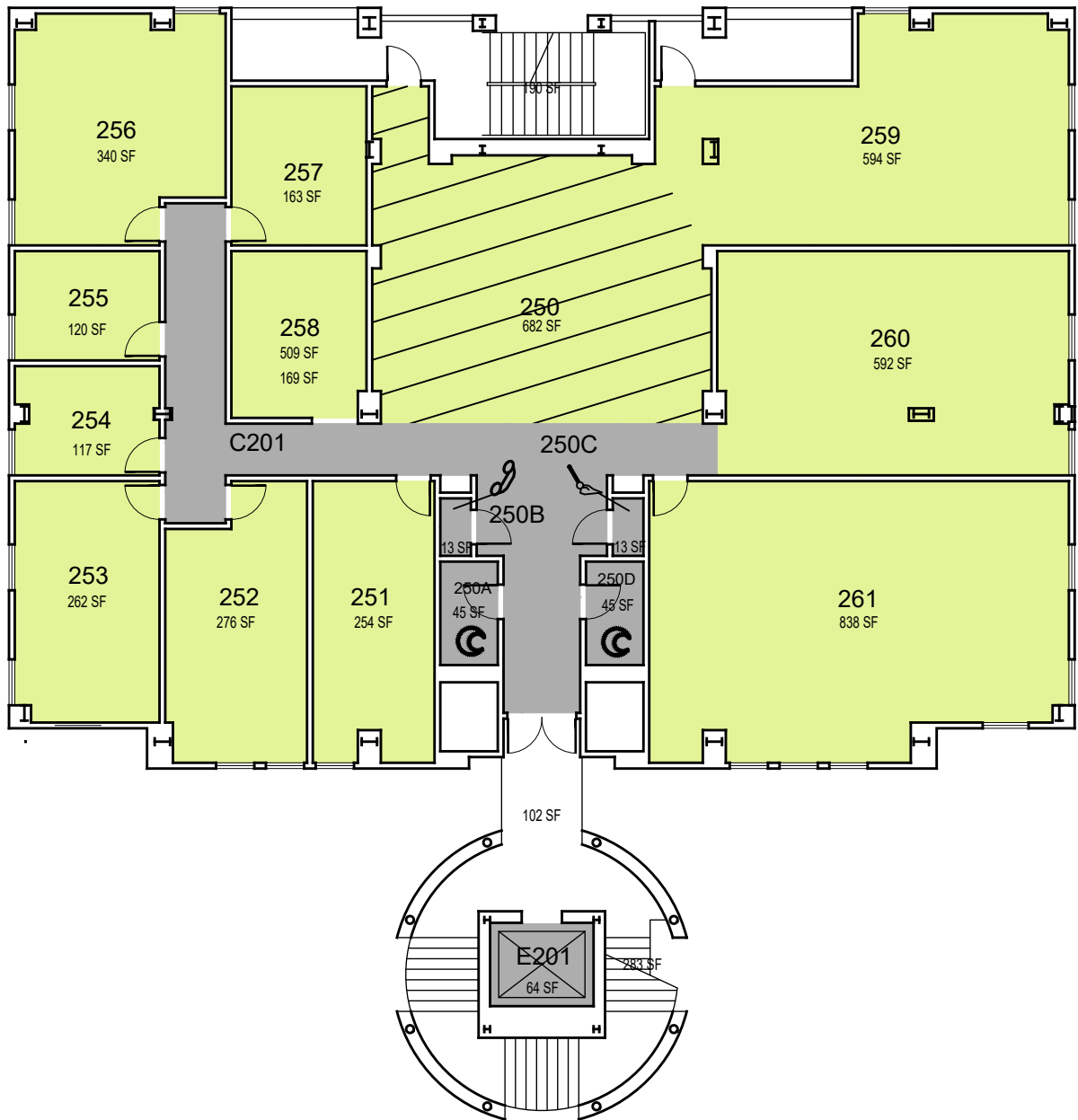

Kinesiology

Floor 2

FACILITIES MANAGEMENT AND DEVELOPMENT

Space Data http://afd.calpoly.edu/facilities/spacefacility/space_data.asp

000 UNASSIGN	400 STUDY	800 HEALTH
100 CLASS	500 SPECIAL	900 RESIDENTIAL
200 LAB	600 GENERAL	
300 OFFICE	700 SUPPORT	

Room Use

March 2022



1"=15'

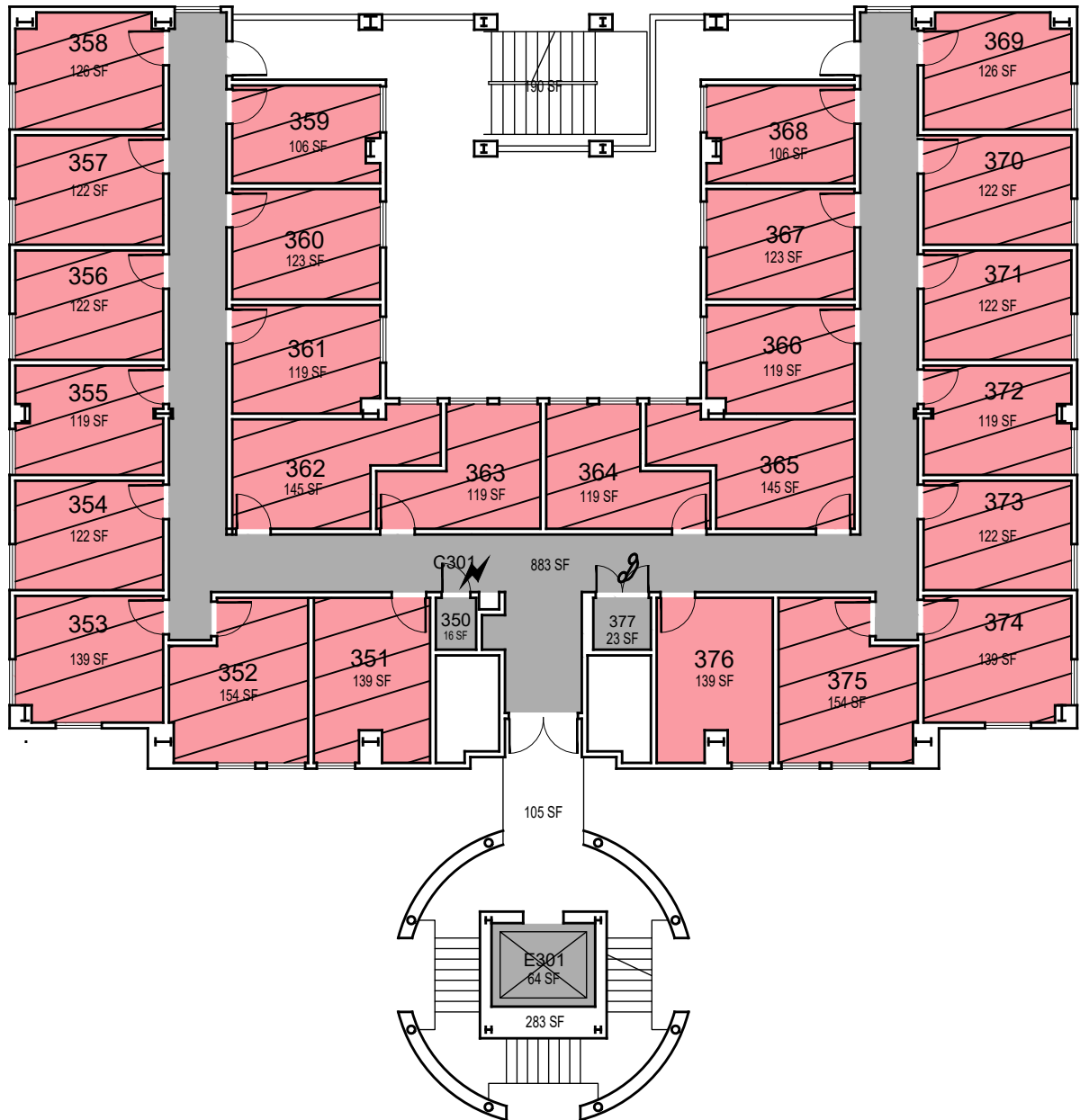

Kinesiology

Floor 3

FACILITIES MANAGEMENT AND DEVELOPMENT

Space Data http://afd.calpoly.edu/facilities/spacefacility/space_data.asp

000 UNASSIGN	400 STUDY	800 HEALTH
100 CLASS	500 SPECIAL	900 RESIDENTIAL
200 LAB	600 GENERAL	
300 OFFICE	700 SUPPORT	

Room Use

March 2022



1"=15'

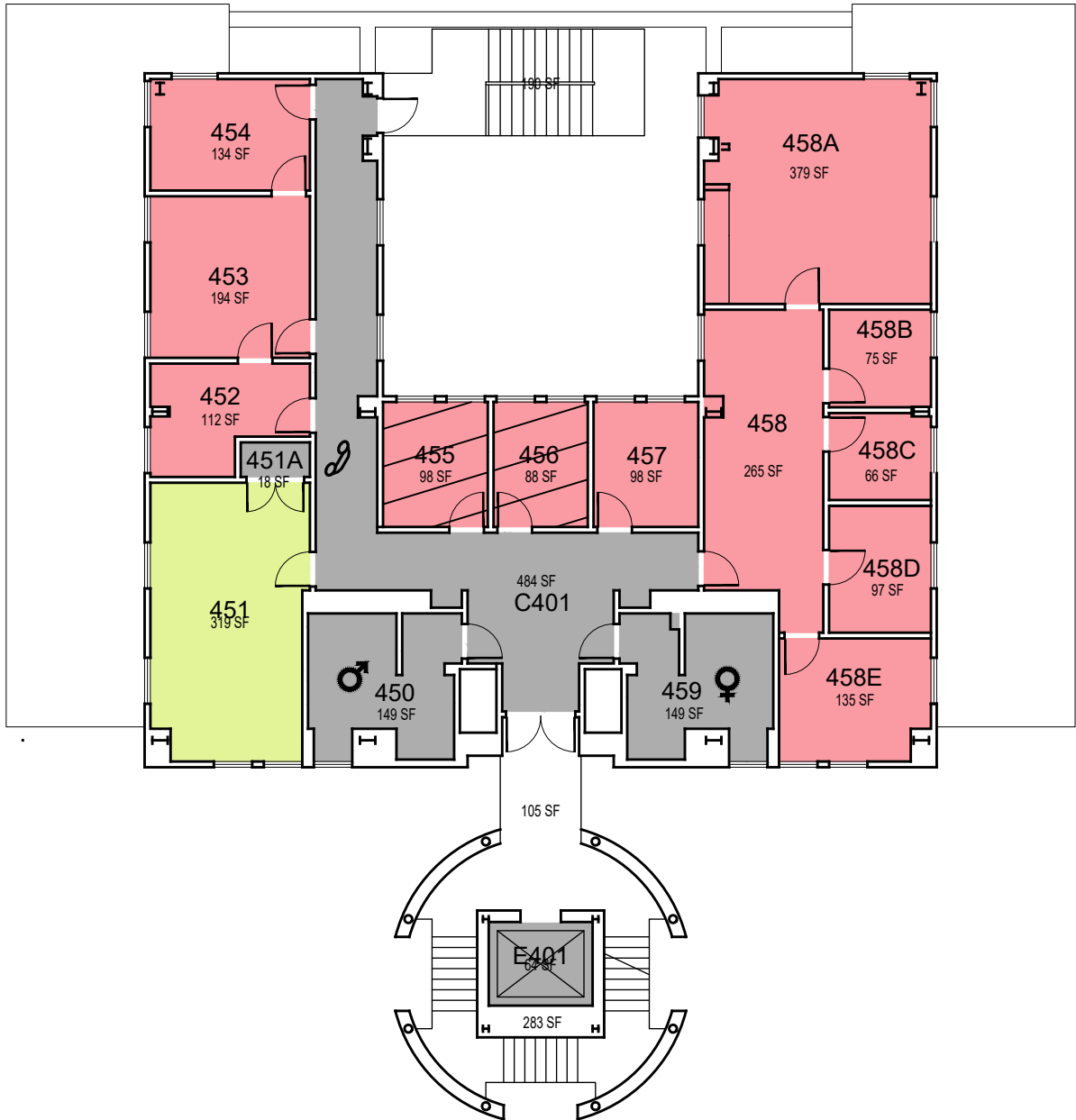

Kinesiology

Floor 4

FACILITIES MANAGEMENT AND DEVELOPMENT

Space Data http://afd.calpoly.edu/facilities/spacefacility/space_data.asp

000 UNASSIGN	400 STUDY	800 HEALTH
100 CLASS	500 SPECIAL	900 RESIDENTIAL
200 LAB	600 GENERAL	
300 OFFICE	700 SUPPORT	

Room Use

March 2022



1"=15'

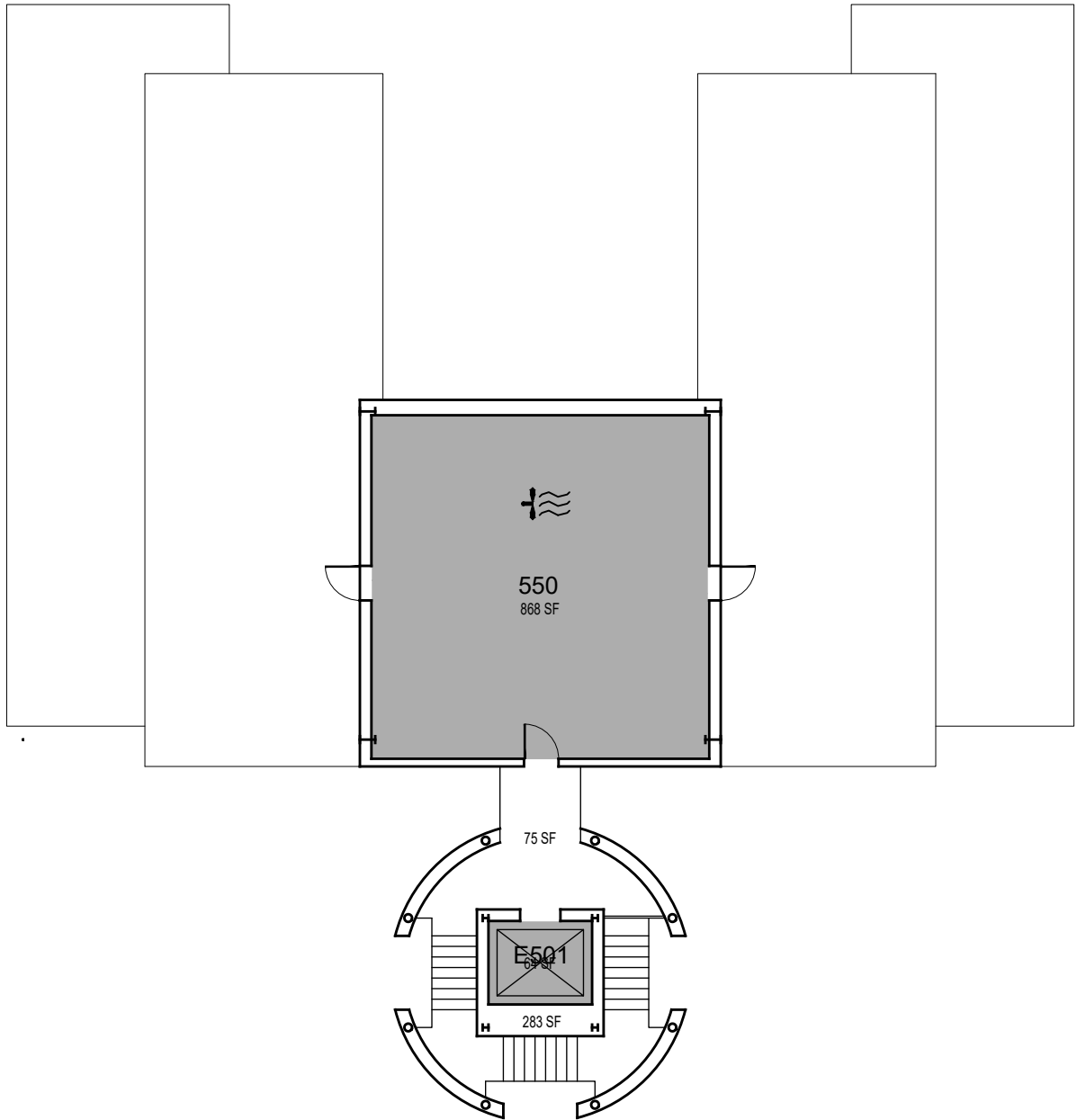

Kinesiology

Mechanical Penthouse

FACILITIES MANAGEMENT AND DEVELOPMENT

Space Data http://afd.calpoly.edu/facilities/spacefacility/space_data.asp

000 UNASSIGN	400 STUDY	800 HEALTH
100 CLASS	500 SPECIAL	900 RESIDENTIAL
200 LAB	600 GENERAL	
300 OFFICE	700 SUPPORT	

Room Use

March 2022

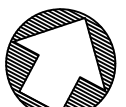

1"=15'